

Single Width Tower
3.2m Long x 0.85m wide

Working Height
13.7m

Platform Height
11.7m

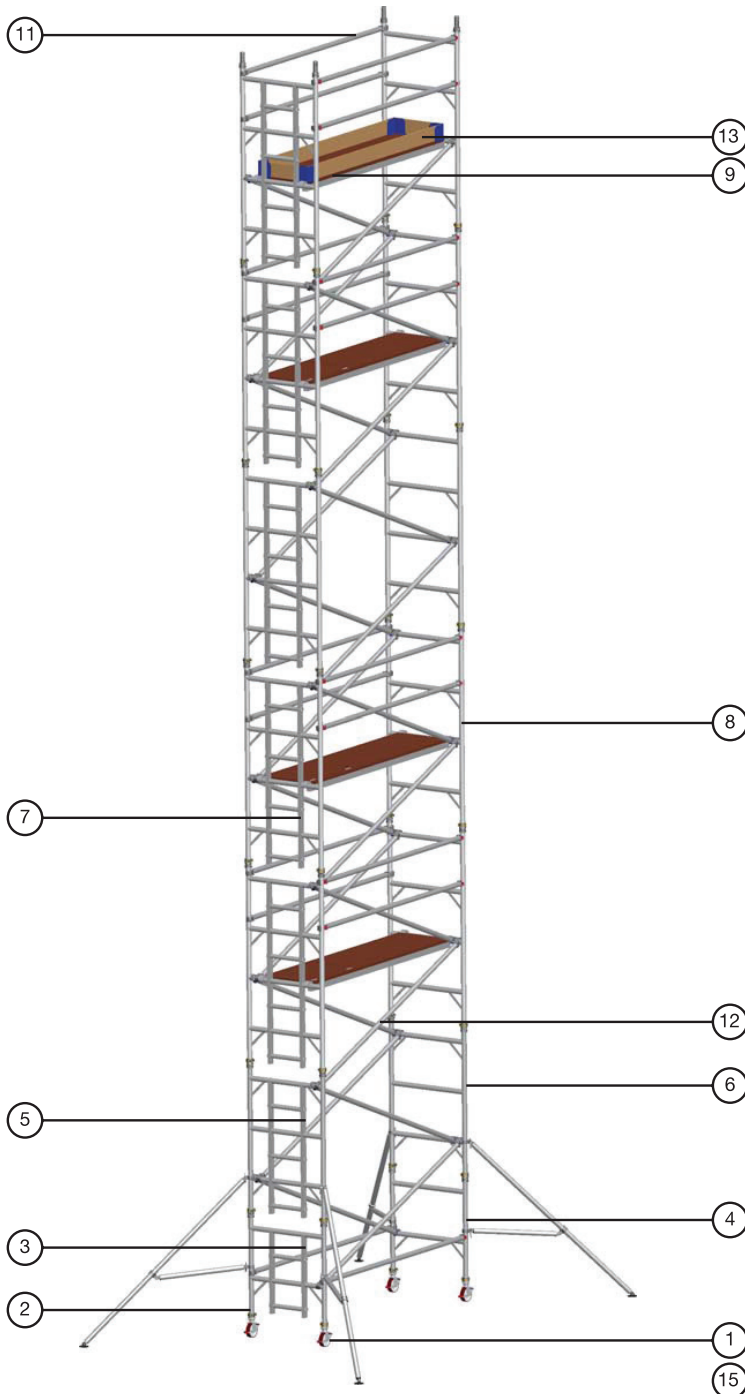

Tower Components

Item	Description	Quantity
1	150mm Locking Castor	4
2	Adjustable Leg 500mm	4
3	2 rung Ladder Frame	1
4	2 rung Span Frame	1
5	3 rung Ladder Frame	1
6	3 rung Span Frame	1
7	4 rung Ladder Frame	5
8	4 rung Span Frame	5
9	3.2m Trapdoor Platform	4
10	Standard Platform	0
11	3.2m Horizontal Brace	18
12	3.5m Diagonal Brace	22
13	Complete Toe Board Set	1
14	Standard Stabilisers	0
15	Jumbo Stabilisers	4
16	Instruction Manual & BSEN1004 certificate of conformity	1

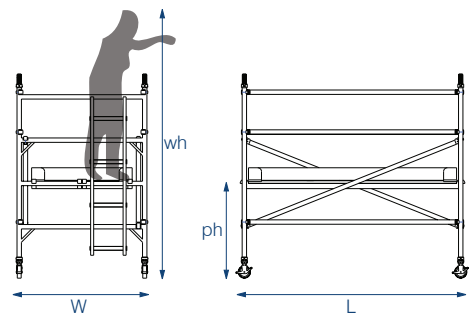

Technical Information

Base Dimensions:	(L)3.2m X (W)0.85m
Maximum Platform Height (ph):	11.7m
Maximum Working Height (wh):	13.7m
Maximum Working Load Per Platform:	275kg
Maximum Working Load Per Tower: (including tower weight)	950kg
Weight:	411kg