

Single Width Tower  
3.2m Long x 0.85m wide

Working Height  
3.2m

Platform Height  
1.2m

### Tower Components

Item	Description	Quantity
1	150mm Locking Castor	4
2	Adjustable Leg 500mm	4
3	2 rung Ladder Frame	0
4	2 rung Span Frame	0
5	3 rung Ladder Frame	0
6	3 rung Span Frame	0
7	4 rung Ladder Frame	1
8	4 rung Span Frame	1
9	3.2m Trapdoor Platform	1
10	Standard Platform	0
11	3.2m Horizontal Brace	6
12	3.5m Diagonal Brace	2
13	Complete Toe Board Set	1
14	Standard Stabilisers	0
15	Jumbo Stabilisers	0
16	Instruction Manual & BSEN1004 certificate of conformity	1

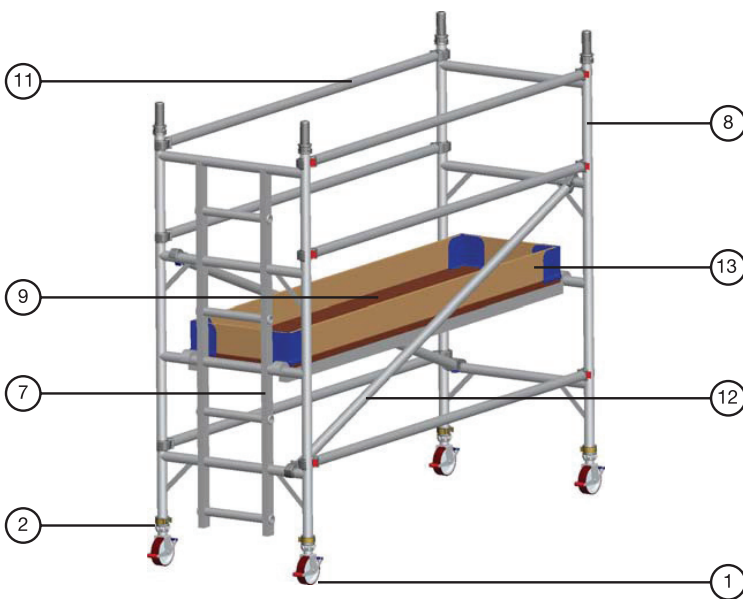

### Technical Information

Base Dimensions:	(L)3.2m X (W)0.85m
Maximum Platform Height (ph):	1.2m
Maximum Working Height (wh):	3.2m
Maximum Working Load Per Platform:	275kg
Maximum Working Load Per Tower: (including tower weight)	950kg
Weight:	113kg