

Single Width Tower
3.2m Long x 0.85m wide

Working Height
8.2m

Platform Height
6.2m

Tower Components

Item	Description	Quantity
1	150mm Locking Castor	4
2	Adjustable Leg 500mm	4
3	2 rung Ladder Frame	1
4	2 rung Span Frame	1
5	3 rung Ladder Frame	0
6	3 rung Span Frame	0
7	4 rung Ladder Frame	3
8	4 rung Span Frame	3
9	3.2m Trapdoor Platform	2
10	Standard Platform	0
11	3.2m Horizontal Brace	10
12	3.5m Diagonal Brace	11
13	Complete Toe Board Set	1
14	Standard Stabilisers	0
15	Jumbo Stabilisers	4
16	Instruction Manual & BSEN1004 certificate of conformity	1

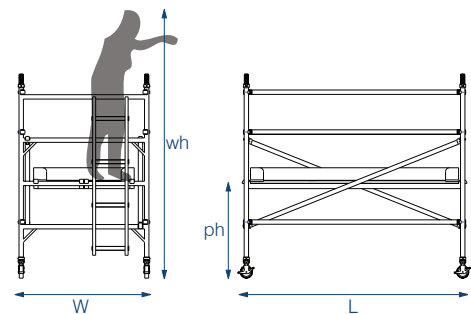
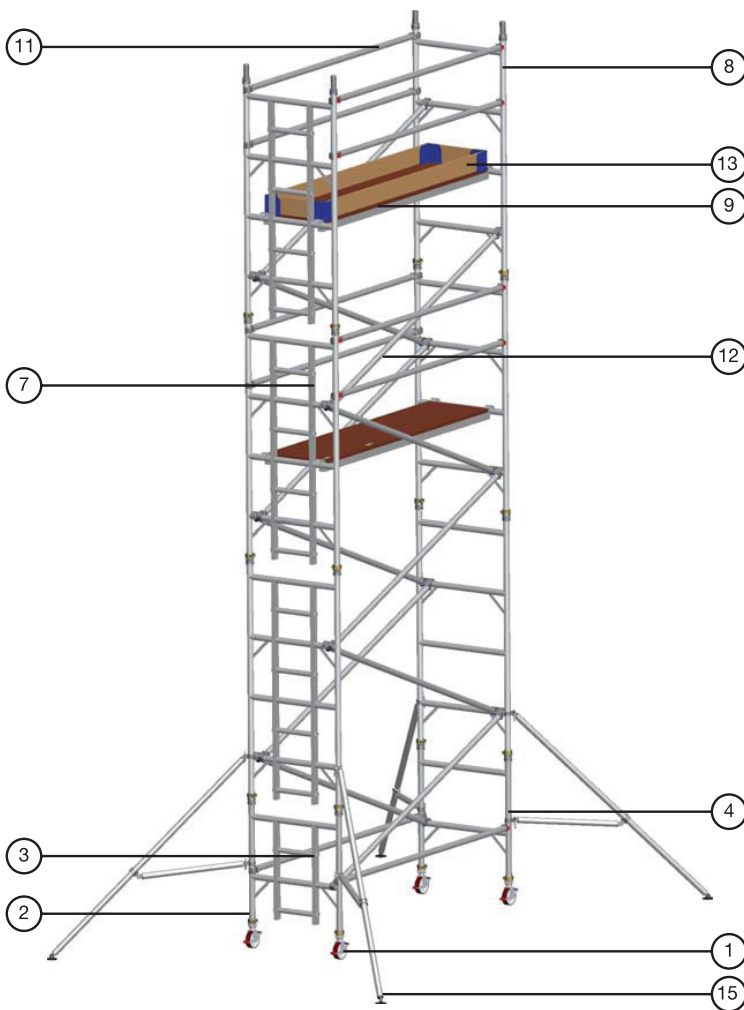

Technical Information

Base Dimensions:	(L)3.2m X (W)0.85m
Maximum Platform Height (ph):	6.2m
Maximum Working Height (wh):	8.2m
Maximum Working Load Per Platform:	275kg
Maximum Working Load Per Tower: (including tower weight)	950kg
Weight:	228kg