

LEWIS

TOWER SYSTEMS



Industrial Ladder Tower

Single Width Tower Assembly Guide

Product Information and Assembly Guide



Single Width Tower Assembly Guide

This document will provide all users of Lewis Access Towers with a complete guide to the erection of the Lewis SW (Single Width) Aluminium Tower, employing the 3T (Through the Trap) method.

The user should read the entire contents of this document before commencing assembly and pay particular attention to all of the safety instructions. If the equipment is passed onto another party a copy of these instructions should accompany the handover.

Two persons are necessary to carry out the erection of the equipment detailed in this document. It is strongly recommended that the following items of personal protection equipment be worn at all times: safety boots (EN345 or BS1870 / 4972); safety helmet (EN397 or BS5240); gloves. The SWL (Safe Working Load) for each platform is 275kg, evenly dispersed.

Additional items, such as steps or conventional ladders, must never be used to gain further height from the platform. The tower must be climbed from within the structure, on no occasions should the tower be scaled from the outside. Inspect all the tower components before each use. Pay particular attention to;

- Castings - check for cracks
- Welds - free from cracks
- Tubes/Braces/Rungs - Straight and with indents less than 5mm deep
- Platforms - no damage, free from debris
- Castors - moves freely, threads free from damage, brake working
- Outriggers - straight, feet flat
- Inspect the equipment for damage regularly, at least daily.

The Lewis Tower is a Class 3 Industrial Tower System

The tower should be manoeuvred into position by hand by pushing it from the base frame. Never attempt to use any mechanical equipment (i.e. a forklift etc.) to move the tower.

If it is necessary to lift individual components whilst assembling the tower, a dependable knot should fasten each item.

Be aware of overhead obstructions – pay particular attention to any live electrical cables. Ensure that no persons, materials or tools are on the tower when it is being moved.

Additional care should be taken when moving the tower on uneven or inclining ground. The use of the castor locks should be deployed when the tower is in position. When moving the tower the stabilisers should only be lifted 35mm from ground level.

Towers under 4m in height are the only towers that should be moved.

- Check all components (see component list) are available and in usable condition.
- Damaged or incorrect components should not be used.

- If damage should occur whilst in use, stop work immediately and isolate the damaged items from the rest of the tower and contact your supplier.
- Check the ground on which the tower is to be used is relatively flat, smooth and capable of supporting the tower.
- The SWL (Safe Working Load) of the tower is 275kg per platform, inc the weight of the tower - evenly distributed, up to a maximum of 950kgs per tower.
- Do not exceed the SWL.
- Never attach safety harnesses or similar safety equipment to the tower whilst erecting or dismantling the tower.
- During assembly, the tower should only be climbed from inside of the frame dimensions, do not scale the tower from the outside.
- Tools and equipment must be loaded onto the platform within the confines of the tower dimensions.
- Adjustable legs are to be used for levelling.
- Outriggers should always be deployed when required.

If the area of operation means that the outriggers cannot be deployed in the recommended position – contact Lewis Towers or your supplier for advice.

Working on the Tower - The Beaufort Windscale

Scale 4. 13 - 18 mph OK TO WORK ON TOWER

Moderate Breeze: Raises dust, loose paper; moves small branches

Scale 5. 19 - 24 mph STOP WORKING ON TOWER

Fresh Breeze: Small trees in leaf begin to sway; white crested wavelets form on inland waters

Scale 6. 25 - 31 mph DISMANTLE TOWER

Strong Breeze: Large branches in motion; umbrellas used with difficulty; telephone wires "whistle".

Be aware that wind conditions are a very important consideration when using a tower. Attention must be paid to individual situations where wind conditions can increase - i.e. when working between buildings, or close to the corner of a building and at open ends.

Never use tarpaulins or similar covers without seeking the correct advice.

Ballast for Towers up to 12.2m in height, ballast is not necessary

SINGLE WIDTH INTERNAL AND EXTERNAL USE

| Working Height in (m) | 3.2 | 3.7 | 4.2 | 4.7 | 5.2 | 5.7 | 5.2 | 6.7 | 7.2 | 7.7 | 8.2 | 8.7 |
|--|-----|-----|-----|-----|-----|-----|-----|-----|-----|-----|-----|-----|
| Platform Height in (m) | 1.2 | 1.7 | 2.2 | 2.7 | 3.2 | 3.7 | 4.2 | 4.7 | 5.2 | 5.7 | 6.2 | 6.7 |
| Castor | 4 | 4 | 4 | 4 | 4 | 4 | 4 | 4 | 4 | 4 | 4 | 4 |
| Adjustable Leg | 4 | 4 | 4 | 4 | 4 | 4 | 4 | 4 | 4 | 4 | 4 | 4 |
| 2 Rung Ladder Frame | 0 | 1 | 1 | 0 | 0 | 1 | 1 | 0 | 0 | 1 | 1 | 0 |
| 2 Rung End Frame | 0 | 1 | 1 | 0 | 0 | 1 | 1 | 0 | 0 | 1 | 1 | 0 |
| 3 Rung Ladder Frame | 0 | 1 | 0 | 1 | 0 | 1 | 0 | 1 | 0 | 1 | 0 | 1 |
| 3 Rung End Frame | 0 | 1 | 0 | 1 | 0 | 1 | 0 | 1 | 0 | 1 | 0 | 1 |
| 4 Rung Ladder Frame | 1 | 0 | 1 | 1 | 2 | 1 | 2 | 2 | 3 | 2 | 3 | 3 |
| 4 Rung End Frame | 1 | 0 | 1 | 1 | 2 | 1 | 2 | 2 | 3 | 2 | 3 | 3 |
| Standard Platform | 0 | 0 | 0 | 0 | 0 | 0 | 0 | 0 | 0 | 0 | 0 | 0 |
| Trapdoor Platform | 1 | 1 | 1 | 1 | 2 | 2 | 2 | 3 | 3 | 3 | 3 | 4 |
| Horizontal Brace | 6 | 6 | 6 | 6 | 10 | 10 | 10 | 14 | 14 | 14 | 14 | 18 |
| Diagonal Brace | 2 | 2 | 3 | 4 | 5 | 6 | 7 | 8 | 9 | 10 | 11 | 12 |
| Toe Board Set | 1 | 1 | 1 | 1 | 1 | 1 | 1 | 1 | 1 | 1 | 1 | 1 |
| Fixed Stabiliser | 0 | 0 | 0 | 4 | 4 | 4 | 4 | 4 | 4 | 4 | 4 | 0 |
| Adjustable Stabiliser | 0 | 0 | 0 | 0 | 0 | 0 | 0 | 0 | 0 | 0 | 0 | 4 |
| Total Self Weight of Tower (Kg) - 1.8m | 74 | 77 | 101 | 107 | 138 | 146 | 151 | 160 | 167 | 176 | 180 | 215 |
| Total Self Weight of Tower (Kg) - 2.5m | 83 | 86 | 110 | 117 | 153 | 163 | 168 | 177 | 184 | 194 | 198 | 240 |

| Working Height in (m) | 9.2 | 9.7 | 10.2 | 10.7 | 11.2 | 11.7 | 12.2 | 12.7 | 13.2 | 13.7 | 14.2 |
|--|-----|-----|------|------|------|------|------|------|------|------|------|
| Platform Height in (m) | 7.2 | 7.7 | 8.2 | 8.7 | 9.2 | 9.7 | 10.2 | 10.7 | 11.2 | 11.7 | 12.2 |
| Castor | 4 | 4 | 4 | 4 | 4 | 4 | 4 | 4 | 4 | 4 | 4 |
| Adjustable Leg | 4 | 4 | 4 | 4 | 4 | 4 | 4 | 4 | 4 | 4 | 4 |
| 2 Rung Ladder Frame | 0 | 1 | 1 | 0 | 0 | 1 | 1 | 0 | 0 | 1 | 1 |
| 2 Rung End Frame | 0 | 1 | 1 | 0 | 0 | 1 | 1 | 0 | 0 | 1 | 1 |
| 3 Rung Ladder Frame | 0 | 0 | 0 | 1 | 0 | 1 | 0 | 1 | 0 | 1 | 0 |
| 3 Rung End Frame | 0 | 0 | 0 | 1 | 0 | 1 | 0 | 1 | 0 | 1 | 0 |
| 4 Rung Ladder Frame | 4 | 4 | 4 | 4 | 5 | 4 | 5 | 5 | 6 | 5 | 6 |
| 4 Rung End Frame | 4 | 4 | 4 | 4 | 5 | 4 | 5 | 5 | 6 | 5 | 6 |
| Standard Platform | 0 | 0 | 0 | 0 | 0 | 0 | 0 | 0 | 0 | 0 | 0 |
| Trapdoor Platform | 4 | 4 | 4 | 5 | 5 | 5 | 5 | 6 | 6 | 6 | 6 |
| Horizontal Brace | 18 | 18 | 18 | 22 | 22 | 22 | 22 | 26 | 26 | 26 | 26 |
| Diagonal Brace | 13 | 15 | 18 | 16 | 17 | 18 | 19 | 20 | 21 | 22 | 23 |
| Toe Board Set | 1 | 1 | 1 | 1 | 1 | 1 | 1 | 1 | 1 | 1 | 1 |
| Fixed Stabiliser | 0 | 0 | 0 | 0 | 0 | 0 | 0 | 0 | 0 | 0 | 0 |
| Adjustable Stabiliser | 4 | 4 | 4 | 4 | 4 | 4 | 4 | 4 | 4 | 4 | 4 |
| Total Self Weight of Tower (Kg) - 1.8m | 252 | 286 | 315 | 271 | 277 | 286 | 290 | 326 | 332 | 339 | 346 |
| Total Self Weight of Tower (Kg) - 2.5m | 278 | 313 | 342 | 304 | 312 | 321 | 326 | 366 | 374 | 381 | 388 |

Single Width Tower Assembly Instructions

- 1.1 Push castor spigot into the adjustable leg. Please see our FAQ Video if you're unsure. Now push castor and adjustable leg assemblies into 2 rung ladder frames.

Note: Base plates can be fitted to adjustable legs replacing the castors if it is not necessary to move the tower that frequently.



- 1.2 Once castors are in place on the 1m Ladder frame repeat the procedure with the 1m Span frame.



- 1.3 Fit one horizontal brace (red) onto the vertical of a span frame, just above the bottom rung, with the claw facing outwards. The frame will now be self-supporting.

Note: make sure all brace is engaged and fully locked.

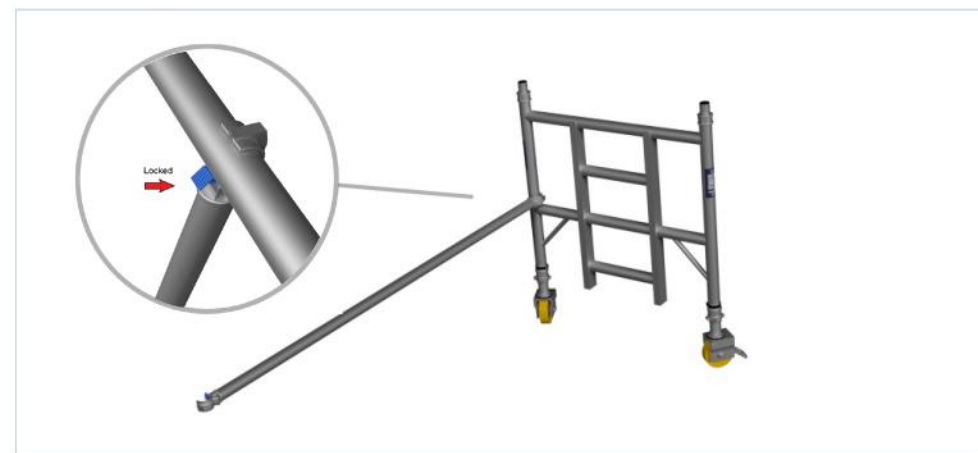

- 1.4 Position the ladder frame as shown and fit the other end of the horizontal brace onto the vertical. Fit a second horizontal brace on the other side of the frames to square the tower.



- 1.5 Fit two additional end frames, ensuring the frame interlock clips are engaged. Fit two diagonal braces (blue) in opposing directions, between the 1st and the 3rd rungs.

Ensure the frames are vertical and level by checking with a spirit level and setting the adjustable legs as required.

IMPORTANT - Only use the adjustable legs to level the tower and not to gain extra height.



- 1.6 Make sure that the trigger is facing to outside of frame.



- 1.7 Fit all four stabilisers to the tower making sure that the rubber feet are touching floor.



1.8 Fit a temporary deck on the lowest rungs. Fit a trapdoor deck on the 4th rung (2.0m) with the trapdoor next to the ladder.

Ensure the trapdoor is positioned with the hinges towards the outside of the tower as shown. Climb the ladder and, from the protected trapdoor position, fit guardrails on the 5th and 6th rungs (in that order) on both sides of the platform.

Do not climb onto the deck until all guardrails are in place.

When horizontal braces are fitted as guardrails, they should be 0.5m and 1.0m (1 and 2 rungs) above the platform level in all cases.



1.9 Add two additional 2m Ladder and Span frames to complete your tower height.



1.10 Add two more diagonal braces between the 5th and 7th - 7th and 9th rungs. If finishing at this height (4.2m platform) reposition the fixed deck to the 8th rung on the tower.



1.11 Add two more diagonal braces between the 5th and 7th - 7th and 9th rungs. If finishing at this height (4.2m platform) reposition the fixed deck to the 8th rung on the tower.



1.12 Continue the procedure until the required working height is reached, adding additional pairs of end frames, diagonal braces and fitting trapdoor platforms, as shown on previous steps. At every platform level, add horizontal braces as guardrails from the protected position within the trapdoor (as shown in Step 1.8). Fit the toe boards

The tower is now complete..



Dismantling

To dismantle the LEWIS single width tower, first remove the toeboard set and send safely down the tower. Remove the furthest of the four guardrails and diagonal brace. Go directly to the trapdoor platform next to the ladder frame to remove the braces completely. To fully dismantle the tower reverse the erection procedure detailed in this guide above.

Stability

Towers left unattended or unused for extended periods in exposed situations should be dismantled. Horizontal forces i.e. pressure exerted when drilling into a building face can yield instability in the tower. The tower must not be used to gain access to a neighbouring structure. Tower are not intended to be suspended.

Transport and Storage

Components should be transported and stored vertically. Damaged items must be repaired by a competent person. Contact your supplier for advice.

Safety Checklist

This inspection must be carried out before initial use, after moving the tower, if any environmental condition change that may affect the tower and at regular intervals determined by local regulations. Local regulations may also specify other information to be supplied to the user. These regulations must be followed.

Pre-Use Checklist

Tower upright and level to within 0.6° Castor brakes locked

All interlock clips engaged

Braces/Guardrails correctly positioned

All claws latched

All platform wind latches engaged

Correct stabiliser size fitted and positioned

Toe boards fitted to working platform

Instruction manual available to user



Using the Tower

This tower must not be used as an anchor point for personal fall arrest equipment.

The tower must only be climbed on the inside, using the access method specified.

This tower provides a work platform. It must not be used to access other structures.

Raising and lowering tools and materials must only be conducted within the tower footprint.

Ensure the safe working load on the structure is not exceeded. See tower designation.

Do not use boxes, stepladders or other objects to gain extra height.

The adjustable legs are for leveling the tower only. They must not be used to gain extra height.

Beware of horizontal forces that might cause instability. Maximum horizontal force = 30kg.

Beware of high winds. This tower has been assessed as a freestanding structure for wind loads equating to 27mph (43kph, 12m/s). If greater wind speeds are forecast the tower must be moved to a sheltered location or dismantled while it is still safe to do so.

Sheets, tarpaulins, or signage must not be attached to this tower outdoors. • Towers above 8.2m platform height are for indoor use only.

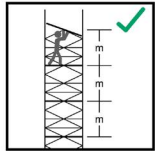

Maximum distance between platforms shall not exceed 2.25m except the distance to the first platform max 3.40m

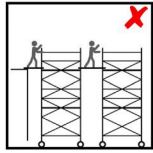

Do not bridge between Towers or other structures
Please contact us for information on the correct equipment for Bridging Towers

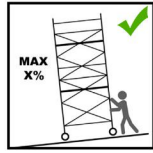

Maximum inclination for movement. Note the maximum angle allowed is defined by the manufacture

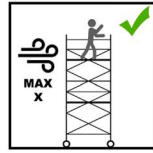

Do not build, dismantle or attempt to work on an access tower if the wind speed exceeds 17MPH

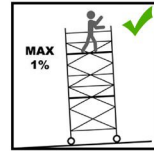

Maximum inclination for movement. Note the maximum angle allowed is defined by the manufacturer

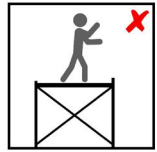

Do not stand on an unguarded platform

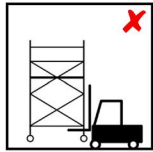

Do not lift the tower with mechanical equipment

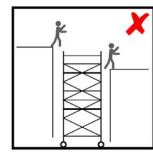

Do not use the tower for access and egress to other structures

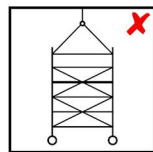

Do not suspend the tower

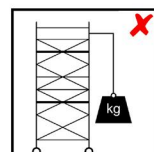

Do not lift heavy objects from the tower

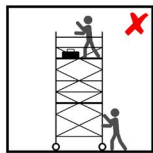

Do not move the tower with people or materials on it

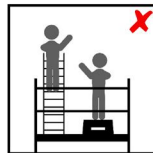

Do not use ladders, boxes or other objects to gain extra height

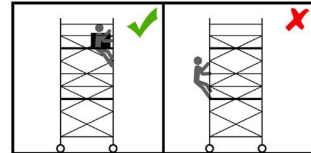

Do not climb the outside of the tower

Horizontal Brace
1.8m / Red Trigger
2.5m / Red Trigger

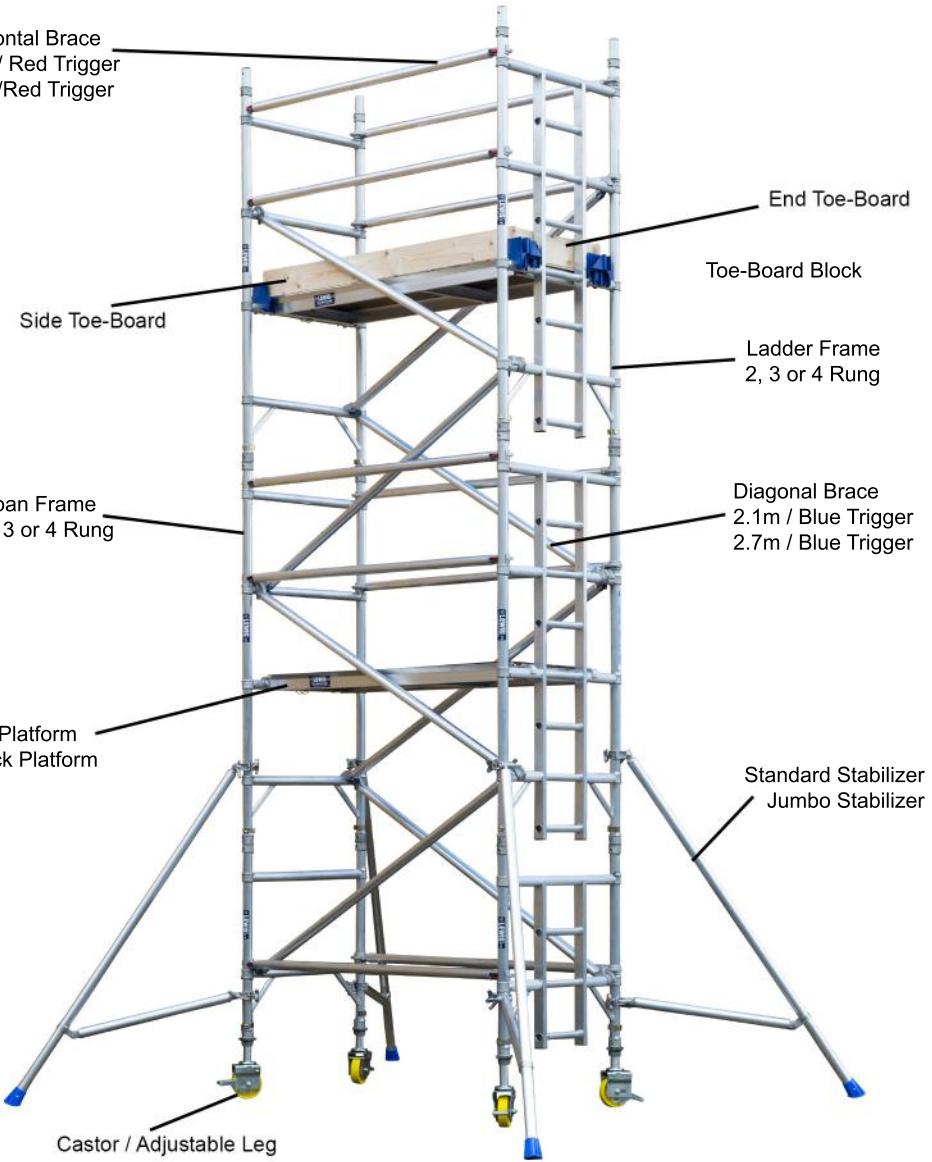

LEWIS

TOWER SYSTEMS

Further Information

For further information and support please contact us on:

0800 043 2222

info@scaffold-tower.co.uk

www.scaffold-tower.co.uk

Unit 1 Bellingham Trading Estate
Franthorne Way
London
SE6 3BX

